

di Vecchi Ivan Alessandro & C.
 Viale Europa, 6 - 24040 Bottanuco (BG) Italy
 P.Iva 01470300169
 N. Iscr. Registro Imprese di Bergamo e Cod. Fisc.: 01470300169
 R.E.A. di Bergamo n. 208600 - N° Albo Artigiani BG - 78898
[http:// www.fratellivecchi.it](http://www.fratellivecchi.it)
 E-mail: info@fratellivecchi.it

NORMA EN 10253.3 - 10253.4

METRICO



Art. 200/M

Tee METRICO standard decapati
 METRIC expanding tee pickled

D	B	2 MM AISI 304	2 MM AISI 316
		COD.ART.	COD.ART.
20	37,0	200M2-20.4	200M2-20.6
28	47,0	200M2-28.4	200M2-28.6
30	47,0	200M2-30.4	200M2-30.6
44,5	62,0	200M2-44.4	200M2-44.6
54	57,0	200M2-54.4	200M2-54.6
84	85,5	200M2-84.4	200M2-84.6
104	105,0	200M2-104.4	200M2-104.6
129	124,0	200M2-129.4	200M2-129.6
154	143,0	200M2-154.4	200M2-154.6
204	178,0	200M2-204.4	200M2-204.6

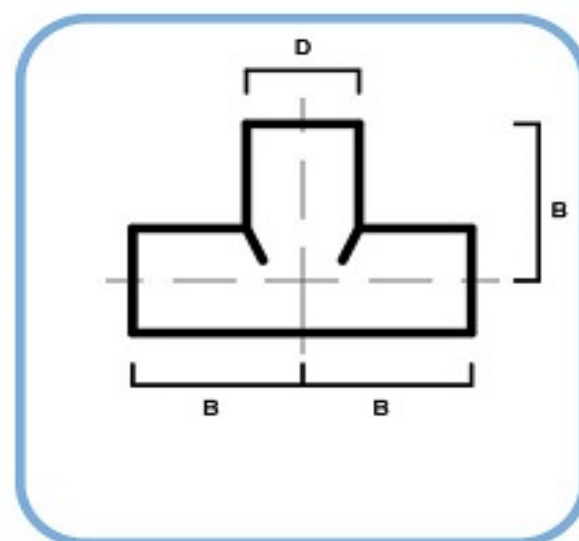

Art. 230/M

Croci METRICO decapate
 METRIC expanding cross pickled

D	B	2 MM AISI 304	2 MM AISI 316
		COD.ART.	COD.ART.
20	37,0	230M2-20.4	230M2-20.6
28	47,0	230M2-28.4	230M2-28.6
30	47,0	230M2-30.4	230M2-30.6
44,5	62,0	230M2-44.4	230M2-44.6
54	57,0	230M2-54.4	230M2-54.6
84	85,5	230M2-84.4	230M2-84.6
104	105,0	230M2-104.4	230M2-104.6
129	124,0	230M2-129.4	230M2-129.6
154	143,0	230M2-154.4	230M2-154.6
204	178,0	230M2-204.4	230M2-204.6

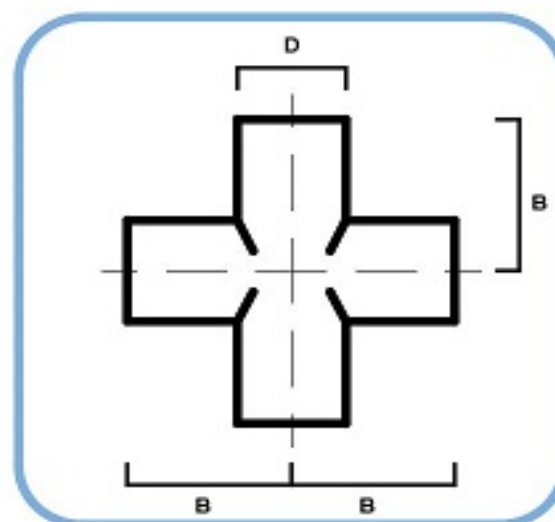

Art. 240/M

Tee METRICO solo sboccati decapati
 METRIC welding tee pickled

D	B	2 MM AISI 304	2 MM AISI 316
		COD.ART.	COD.ART.
20	37,0	240M2-20.4	240M2-20.6
28	47,0	240M2-28.4	240M2-28.6
30	47,0	240M2-30.4	240M2-30.6
44,5	62,0	240M2-44.4	240M2-44.6
54	57,0	240M2-54.4	240M2-54.6
84	85,5	240M2-84.4	240M2-84.6
104	105,0	240M2-104.4	240M2-104.6
129	124,0	240M2-129.4	240M2-129.6
154	143,0	240M2-154.4	240M2-154.6
204	178,0	240M2-204.4	240M2-204.6

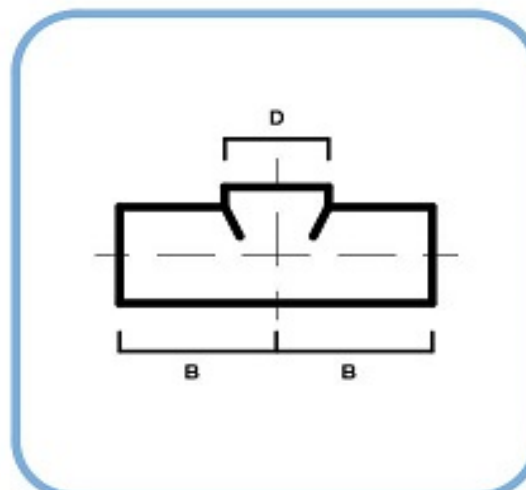

Art. 220/M

Tee ridotti METRICO decapati

METRIC reducing tee pickled

			2 MM AISI 304			2 MM AISI 316
D	A	B	COD.ART.			COD.ART.
28	20	47,00	220M2-28/20.6			220M2-28/20.6
30	20	47,00	220M2-30/20.4			220M2-30/20.6
	28		220M2-30/28.4			220M2-30/28.6
44,5	20	62,00	220M2-44/20.4			220M2-44/20.6
	28		220M2-44/28.4			220M2-44/28.6
	30		220M2-44/30.4			220M2-44/30.6
54	20	57,00	220M2-54/20.4			220M2-54/20.6
	28		220M2-54/28.4			220M2-54/28.6
	30		220M2-54/30.4			220M2-54/30.6
	44,5		220M2-54/44.4			220M2-54/44.6
84	20	85,50	220M2-84/20.4			220M2-84/20.6
	28		220M2-84/28.4			220M2-84/28.6
	30		220M2-84/30.4			220M2-84/30.6
	44,5		220M2-84/44.4			220M2-84/44.6
	54		220M2-84/54.4			220M2-84/54.6
104	20	105,00	220M2-104/20.4			220M2-104/20.6
	28		220M2-104/28.4			220M2-104/28.6
	30		220M2-104/30.4			220M2-104/30.6
	44,5		220M2-104/44.4			220M2-104/44.6
	54		220M2-104/54.4			220M2-104/54.6
	84		220M2-104/84.4			220M2-104/84.6
129	20	124,00	220M2-129/20.4			220M2-129/20.6
	28		220M2-129/28.4			220M2-129/28.6
	30		220M2-129/30.4			220M2-129/30.6
	44,5		220M2-129/44.4			220M2-129/44.6
	54		220M2-129/54.4			220M2-129/54.6
	84		220M2-129/84.4			220M2-129/84.6
154	20	143,00	220M2-154/20.4			220M2-154/20.6
	28		220M2-154/28.4			220M2-154/28.6
	30		220M2-154/30.4			220M2-154/30.6
	44,5		220M2-154/44.4			220M2-154/44.6
	54		220M2-154/54.4			220M2-154/54.6
	84		220M2-154/84.4			220M2-154/84.6
	104		220M2-154/104.4			220M2-154/104.6
	129		220M2-154/129.4			220M2-154/129.6
204	20	178,0	220M2-204/20.4			220M2-204/20.6
	28		220M2-204/28.4			220M2-204/28.6
	30		220M2-204/30.4			220M2-204/30.6
	44,5		220M2-204/44.4			220M2-204/44.6
	54		220M2-204/54.4			220M2-204/54.6
	84		220M2-204/84.4			220M2-204/84.6
	104		220M2-204/104.4			220M2-204/104.6
	129		220M2-204/129.4			220M2-204/129.6
	154		220M2-204/154.4			220M2-204/154.6

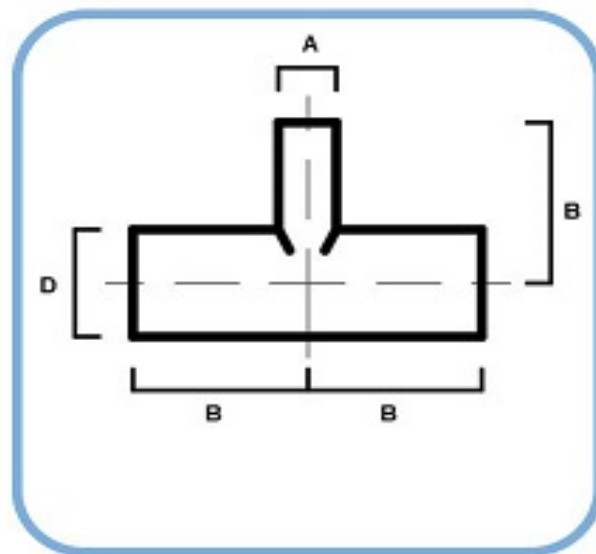

Art. 250/M

Tee ridotti sboccati decapati METRICO

METRIC reducing tee extruder pickled

D	A	B	2 MM AISI 304	2 MM AISI 316
			COD.ART.	COD.ART.
28	20	47,00	250M2-28/20.6	250M2-28/20.6
30	20	47,00	250M2-30/20.4	250M2-30/20.6
	28		250M2-30/28.4	250M2-30/28.6
44,5	20	62,00	250M2-44/20.4	250M2-44/20.6
	28		250M2-44/28.4	250M2-44/28.6
	30		250M2-44/30.4	250M2-44/30.6
54	20	57,00	250M2-54/20.4	250M2-54/20.6
	28		250M2-54/28.4	250M2-54/28.6
	30		250M2-54/30.4	250M2-54/30.6
	44,5		250M2-54/44.4	250M2-54/44.6
84	20	85,50	250M2-84/20.4	250M2-84/20.6
	28		250M2-84/28.4	250M2-84/28.6
	30		250M2-84/30.4	250M2-84/30.6
	44,5		250M2-84/44.4	250M2-84/44.6
	54		250M2-84/54.4	250M2-84/54.6
104	20	105,00	250M2-104/20.4	250M2-104/20.6
	28		250M2-104/28.4	250M2-104/28.6
	30		250M2-104/30.4	250M2-104/30.6
	44,5		250M2-104/44.4	250M2-104/44.6
	54		250M2-104/54.4	250M2-104/54.6
	84		250M2-104/84.4	250M2-104/84.6
129	20	124,00	250M2-129/20.4	250M2-129/20.6
	28		250M2-129/28.4	250M2-129/28.6
	30		250M2-129/30.4	250M2-129/30.6
	44,5		250M2-129/44.4	250M2-129/44.6
	54		250M2-129/54.4	250M2-129/54.6
	84		250M2-129/84.4	250M2-129/84.6
	104		250M2-129/104.4	250M2-129/104.6
154	20	143,00	250M2-154/20.4	250M2-154/20.6
	28		250M2-154/28.4	250M2-154/28.6
	30		250M2-154/30.4	250M2-154/30.6
	44,5		250M2-154/44.4	250M2-154/44.6
	54		250M2-154/54.4	250M2-154/54.6
	84		250M2-154/84.4	250M2-154/84.6
	104		250M2-154/104.4	250M2-154/104.6
	129		250M2-154/129.4	250M2-154/129.6
	204		250M2-154/204.4	250M2-154/204.6
204	20	178,0	250M2-204/20.4	250M2-204/20.6
	28		250M2-204/28.4	250M2-204/28.6
	30		250M2-204/30.4	250M2-204/30.6
	44,5		250M2-204/44.4	250M2-204/44.6
	54		250M2-204/54.4	250M2-204/54.6
	84		250M2-204/84.4	250M2-204/84.6
	104		250M2-204/104.4	250M2-204/104.6
	129		250M2-204/129.4	250M2-204/129.6
	154		250M2-204/154.4	250M2-204/154.6

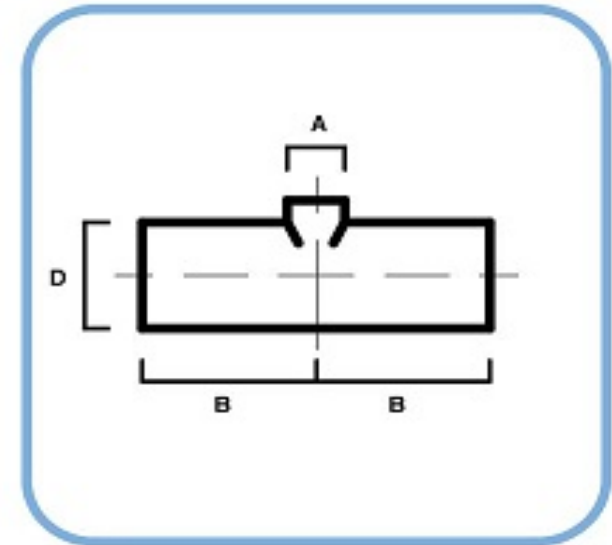

Art. 260/M

Croci ridotte saldate decapate METRICO

Reduced crosses METRIC pickled

D	A	B	2 MM AISI 304	2 MM AISI 316
			COD.ART.	COD.ART.
28	20	47,00	260M2-28/20.4	260M2-28/20.6
30	20	47,00	260M2-30/20.4	260M2-30/20.6
	28		260M2-30/28.4	260M2-30/28.6
44,5	20	62,00	260M2-44/20.4	260M2-44/20.6
	28		260M2-44/28.4	260M2-44/28.6
	30		260M2-44/30.4	260M2-44/30.6
54	20	57,00	260M2-54/20.4	260M2-54/20.6
	28		260M2-54/28.4	260M2-54/28.6
	30		260M2-54/30.4	260M2-54/30.6
	44,5		260M2-54/44.4	260M2-54/44.6
84	20	85,50	260M2-84/20.4	260M2-84/20.6
	28		260M2-84/28.4	260M2-84/28.6
	30		260M2-84/30.4	260M2-84/30.6
	44,5		260M2-84/44.4	260M2-84/44.6
104	20	105,00	260M2-104/20.4	260M2-104/20.6
	28		260M2-104/28.4	260M2-104/28.6
	30		260M2-104/30.4	260M2-104/30.6
	44,5		260M2-104/44.4	260M2-104/44.6
	54		260M2-104/54.4	260M2-104/54.6
129	20	124,00	260M2-129/20.4	260M2-129/20.6
	28		260M2-129/28.4	260M2-129/28.6
	30		260M2-129/30.4	260M2-129/30.6
	44,5		260M2-129/44.4	260M2-129/44.6
	54		260M2-129/54.4	260M2-129/54.6
	84		260M2-129/84.4	260M2-129/84.6
154	20	143,00	260M2-154/20.4	260M2-154/20.6
	28		260M2-154/28.4	260M2-154/28.6
	30		260M2-154/30.4	260M2-154/30.6
	44,5		260M2-154/44.4	260M2-154/44.6
	54		260M2-154/54.4	260M2-154/54.6
	84		260M2-154/84.4	260M2-154/84.6
	104		260M2-154/104.4	260M2-154/104.6
	129		260M2-154/129.4	260M2-154/129.6
204	20	178,0	260M2-204/20.4	260M2-204/20.6
	28		260M2-204/28.4	260M2-204/28.6
	30		260M2-204/30.4	260M2-204/30.6
	44,5		260M2-204/44.4	260M2-204/44.6
	54		260M2-204/54.4	260M2-204/54.6
	84		260M2-204/84.4	260M2-204/84.6
	104		260M2-204/104.4	260M2-204/104.6
	129		260M2-204/129.4	260M2-204/129.6
	154		260M2-204/154.4	260M2-204/154.6

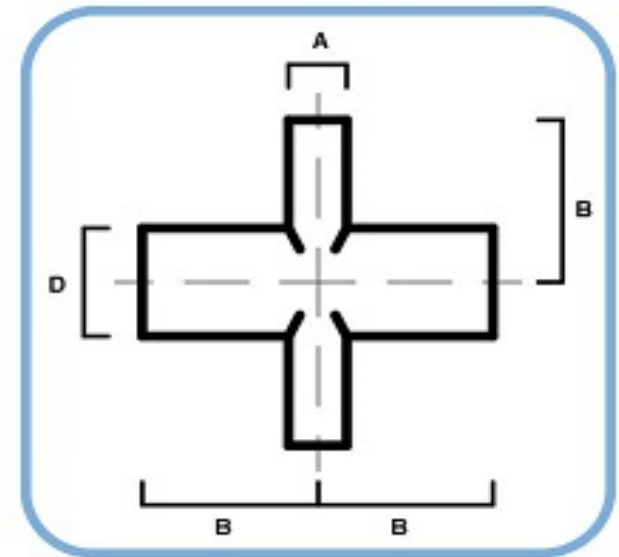

Art. 270/M

Croci ridotte stampate METRICO decapate

Welded reduced crosses METRIC pickled

D	A	B	2 MM AISI 304	2 MM AISI 316
			COD.ART.	COD.ART.
28	20	47,00	270M2-28/20.4	270M2-28/20.6
30	20	47,00	270M2-30/20.4	270M2-30/20.6
	28		270M2-30/28.4	270M2-30/28.6
44,5	20	62,00	270M2-44/20.4	270M2-44/20.6
	28		270M2-44/28.4	270M2-44/28.6
	30		270M2-44/30.4	270M2-44/30.6
54	20	57,00	270M2-54/20.4	270M2-54/20.6
	28		270M2-54/28.4	270M2-54/28.6
	30		270M2-54/30.4	270M2-54/30.6
	44,5		270M2-54/44.4	270M2-54/44.6
84	20	85,50	270M2-84/20.4	270M2-84/20.6
	28		270M2-84/28.4	270M2-84/28.6
	30		270M2-84/30.4	270M2-84/30.6
	44,5		270M2-84/44.4	270M2-84/44.6
	54		270M2-84/54.4	270M2-84/54.6
104	20	105,00	270M2-104/20.4	270M2-104/20.6
	28		270M2-104/28.4	270M2-104/28.6
	30		270M2-104/30.4	270M2-104/30.6
	44,5		270M2-104/44.4	270M2-104/44.6
	54		270M2-104/54.4	270M2-104/54.6
	84		270M2-104/84.4	270M2-104/84.6
129	20	124,00	270M2-129/20.4	270M2-129/20.6
	28		270M2-129/28.4	270M2-129/28.6
	30		270M2-129/30.4	270M2-129/30.6
	44,5		270M2-129/44.4	270M2-129/44.6
	54		270M2-129/54.4	270M2-129/54.6
	84		270M2-129/84.4	270M2-129/84.6
	104		270M2-129/104.4	270M2-129/104.6
154	20	143,00	270M2-154/20.4	270M2-154/20.6
	28		270M2-154/28.4	270M2-154/28.6
	30		270M2-154/30.4	270M2-154/30.6
	44,5		270M2-154/44.4	270M2-154/44.6
	54		270M2-154/54.4	270M2-154/54.6
	84		270M2-154/84.4	270M2-154/84.6
	104		270M2-154/104.4	270M2-154/104.6
	129		270M2-154/129.4	270M2-154/129.6
204	20	178,0	270M2-204/20.4	270M2-204/20.6
	28		270M2-204/28.4	270M2-204/28.6
	30		270M2-204/30.4	270M2-204/30.6
	44,5		270M2-204/44.4	270M2-204/44.6
	54		270M2-204/54.4	270M2-204/54.6
	84		270M2-204/84.4	270M2-204/84.6
	104		270M2-204/104.4	270M2-204/104.6
	129		270M2-204/129.4	270M2-204/129.6
	154		270M2-204/154.4	270M2-204/154.6

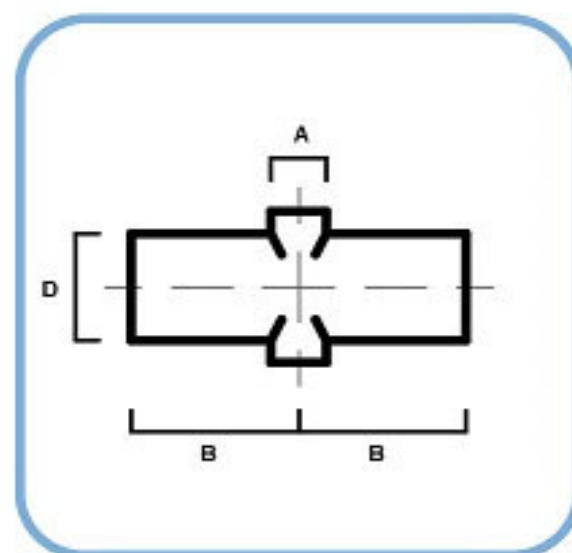

Art. /300YM

Y METRICO decapate 120°

Y METRIC pickled 120°

D	COD.ART.	COD.ART.
	304L	316L
20	300YM-20.4	300YM-20.6
28	300YM-28.4	300YM-28.6
30	300YM-30.4	300YM-30.6
44,5	300YM-44.4	300YM-44.6
54	300YM-54.4	300YM-54.6
84	300YM-84.4	300YM-84.6
104	300YM-104.4	300YM-104.6
129	300YM-129.4	300YM-129.6
154	300YM-154.4	300YM-154.6
204	300YM-204.4	300YM-204.6

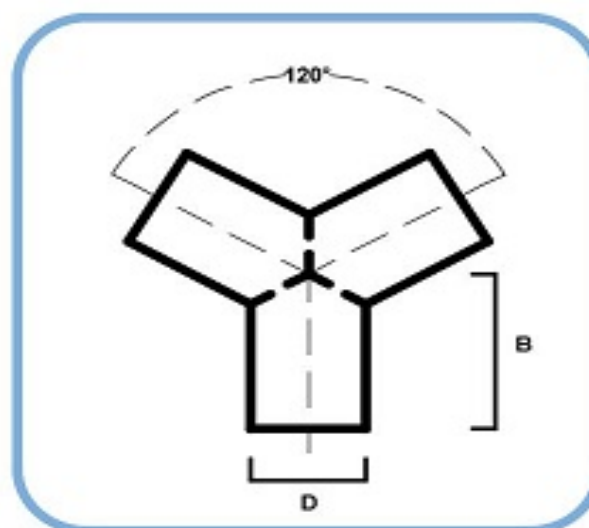

Art. .305/YM

Y METRICO decapate 90°

Y METRIC pickled 90°

D	COD.ART.	COD.ART.
	304L	316L
20	305YM-20.4	305YM-20.6
28	305YM-28.4	305YM-28.6
30	305YM-30.4	305YM-30.6
44,5	305YM-44.4	305YM-44.6
54	305YM-54.4	305YM-54.6
84	305YM-84.4	305YM-84.6
104	305YM-104.4	305YM-104.6
129	305YM-129.4	305YM-129.6
154	305YM-154.4	305YM-154.6
204	305YM-204.4	305YM-204.6

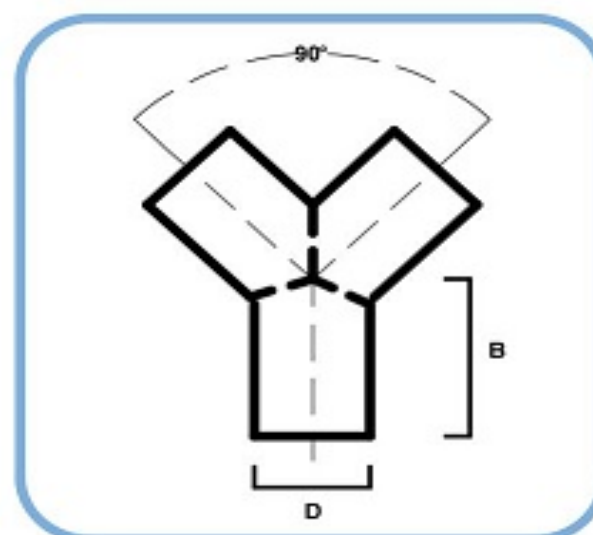

Art. 310/EM

Tee con curva METRICO decapati

Tee with band METRIC pickled

D	COD.ART.	COD.ART.
	304L	316L
20	310EM-20.4	310EM-20.6
28	310EM-28.4	310EM-28.6
30	310EM-30.4	310EM-30.6
44,5	310EM-44.4	310EM-44.6
54	310EM-54.4	310EM-54.6
84	310EM-84.4	310EM-84.6
104	310EM-104.4	310EM-104.6
129	310EM-129.4	310EM-129.6
154	310EM-154.4	310EM-154.6
204	310EM-204.4	310EM-204.6

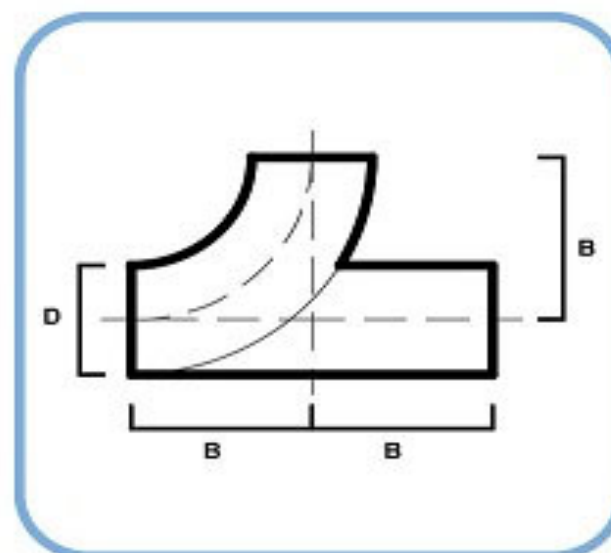

Art .320/KM

Tee 45° METRICO decapati

Tee 45° METRIC pickled

	D		COD.ART.		COD.ART.
			304L		316L
	20		320KM-20.4		320KM-20.6
	28		320KM-28.4		320KM-28.6
	30		320KM-30.4		320KM-30.6
	44,5		320KM-44.4		320KM-44.6
	54		320KM-54.4		320KM-54.6
	84		320KM-84.4		320KM-84.6
	104		320KM-104.4		320KM-104.6
	129		320KM-129.4		320KM-129.6
	154		320KM-154.4		320KM-154.6
	204		320KM-204.4		320KM-204.6

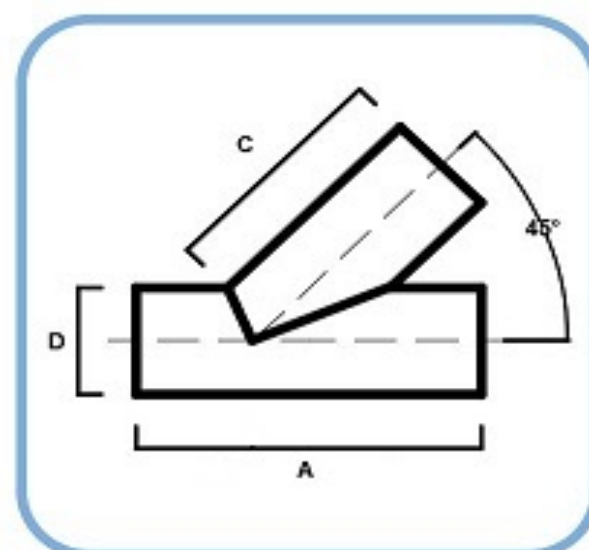

Art. 325/DM

Doppia curva METRICO decapati

Double bend METRIC pickled

	D		COD.ART.		COD.ART.
			304L		316L
	20		325DM-20.4		325DM-20.6
	28		325DM-28.4		325DM-28.6
	30		325DM-30.4		325DM-30.6
	44,5		325DM-44.4		325DM-44.6
	54		325DM-54.4		325DM-54.6
	84		325DM-84.4		325DM-84.6
	104		325DM-104.4		325DM-104.6
	129		325DM-129.4		325DM-129.6
	154		325DM-154.4		325DM-154.6
	204		325DM-204.4		325DM-204.6

